

Annotation Features

Introduction

Wildfire 5.0 includes enhancements to **Annotation** features as listed below.

Align Dimensions	Dimensions that are created as part of annotation features can now be aligned.
Angle Dimensions	The Move Text command in the Dimension Properties dialog box is now available for angle dimensions.
Annotation Orientation	There is a new option that forces new annotation elements to be placed on the active reference plane.
Cross Section Edges	Annotation elements can now be attached to the edges created by cross sections.
Datum Targets	There is a new annotation feature for creating datum targets.
Designated Areas	Annotation elements can reference the new Designated Area feature.
Move to Plane	There are new options for moving existing annotations to alternate planes.
Quick Print	The Quick Print command now includes an option to print annotation elements that are created using the Flat to Screen placement option.
Surface Finish	There are enhancements to surface finish annotations as listed on page 122.
Text Style	The text style of multiple annotations can now be changed at the same time.

Align Dimensions

Dimensions that are created as part of annotation features can now be aligned.

- Set the selection filter to *Annotation*.
- Select multiple dimensions then click **Align Dimensions** in the RMB popup menu as shown below.

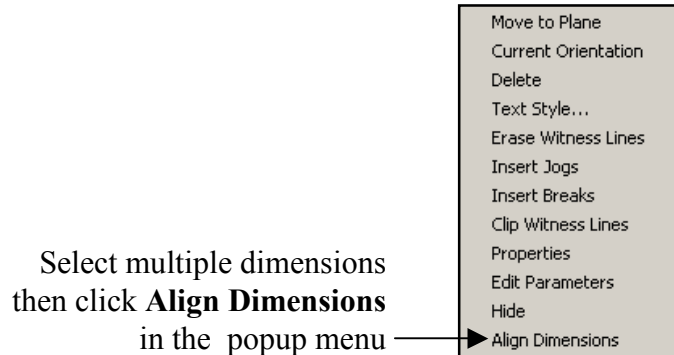

- The dimensions are aligned to the location of the first dimension selected.

Tutorial – Align Dimensions

- **Open** the part called ‘align_annotation.prt’
- Set the selection filter to *Annotation*
- Select the three dimensions then click **Align Dimensions** in the RMB popup menu
- Notice the dimensions have been aligned with the first dimension that you selected
- **Save** the part and **Close** the window

Angle Dimensions

The **Move Text** command in the **Dimension Properties** dialog box is now available for angle dimensions.

- Set the selection filter to *Annotation*.
- Select an angle dimension then click **Properties** in the RMB popup menu.
- Click **Move Text** in the **Dimension Properties** dialog box.
- Click a new location for the dimension text along the dimension line.
- Click **OK** in the **Dimension Properties** dialog box.

Tutorial – Angle Dimensions

- **Open** the part called ‘angle_annotation.prt’
- Set the selection filter to *Annotation*
- Select the angle dimension then click **Properties** in the RMB popup menu.
- Click **Move Text** in the **Dimension Properties** dialog box
- Click a new location for the dimension text along the dimension line
- Click **OK** in the **Dimension Properties** dialog box
- **Save** the part and **Close** the window

Annotation Orientation

There is a new option that forces new annotation elements to be placed on the active reference plane.

- Click **View, Annotation Orientation**.
- Click **Reference Plane** then select a planar surface or datum plane.
- Add the checkmark next to **Place Annotations on Reference Plane** as shown below.

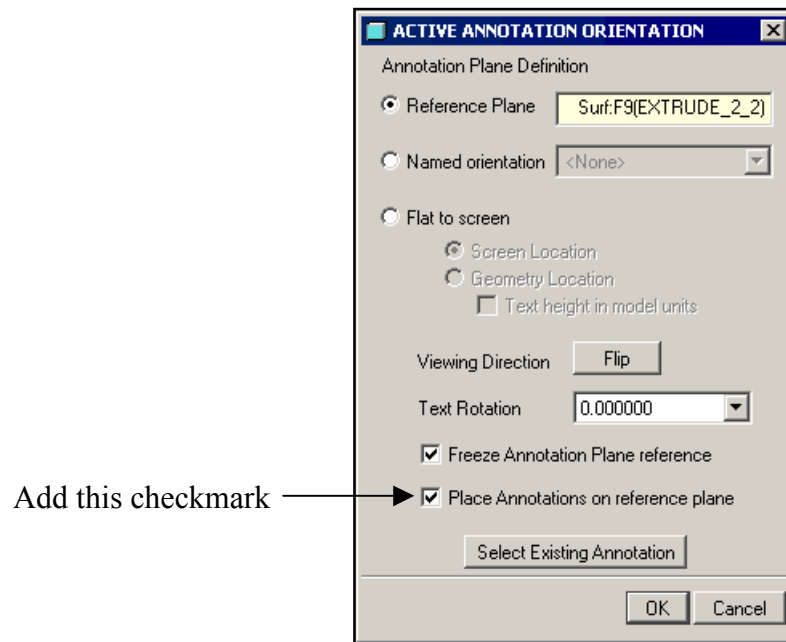



- The system creates dashed gray lines extending back to the original references. The new configuration option called `display_z_extension_lines` controls this behavior.

Tutorial – Annotation Orientation

- **Open** the part called ‘annotation_orientation.prt’
- Click **View, Annotation Orientation**
- Click **Reference Plane** then select the RIGHT datum plane
- Select **270** for the **Text Rotation**
- Add the checkmark next to **Place Annotations on Reference Plane**

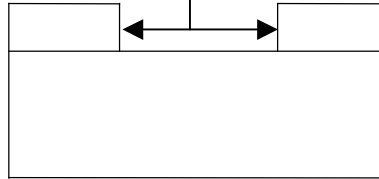
- Click **OK** in the **Active Annotation Orientation** dialog box
- Click **View, Orientation, Active Annotation Orientation**
- Click **Insert, Annotations, Annotation Feature** or pick the icon 
- Click **Driven Dimension** and **OK** in the **Add Annotation** dialog box
- Select these two edges



- Click the middle mouse button here  to place the dimension
- Click **OK** in the **Annotation Feature** dialog box
- Click **View, Orientation, Standard Orientation**
- Notice the dimension is placed on the RIGHT datum plane with dashed gray lines extending back to the selected edges as shown below

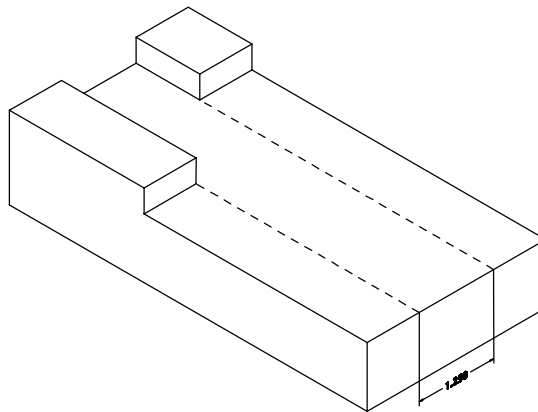

- You can disable the display of the dashed gray lines using the configuration option listed below.



```
display_z_extension_lines no
```

- **Save** the part and **Close** the window

Cross Section Edges

Annotation elements can now be attached to the edges created by cross sections.

Tutorial – Cross Section Edges

- **Open** the part called ‘4455-005.prt’
- Click **View, View Manager** or click the icon 
- Click the *Xsec* tab in the **View Manager**
- Double click the section called **C** to activate it
- **Close** the **View Manager**
- Click **Insert, Annotations, Annotation Feature** or pick the icon 
- Click **Driven Dimension** and **OK** in the **Add Annotation** dialog box
- Select the left vertical edge of the cross section, then select the right vertical edge of the cross section, then click the middle mouse button in an appropriate location to place the dimension as shown below

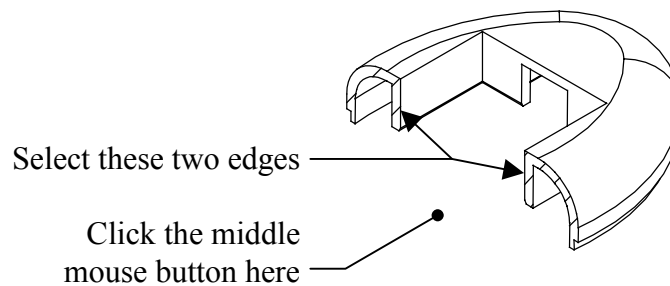



- Click **OK** in the **Annotation Feature** dialog box
- **Save** the part and **Close** the window

Datum Targets

There is a new annotation feature for creating datum targets.

- Click **Insert, Annotations, Datum Target Annotation Feature** or click the icon. 
- Click **OK** in the **Add Annotation** dialog box.
- Select a datum plane or planar surface then enter a name for the set datum.
- Choose the appropriate placement option then click **OK** in the **Set Datum Tag** dialog box.
- Click **Add** in the **Datum Target Annotation Feature** dialog box.
- Click **Browse** then locate and select the appropriate symbol then click **Open**.
- Some datum target symbols have additional text for the upper portion of the symbol
- Place the symbol on the model then click **OK** in the **Datum Target Symbol** dialog box.
- Click **Add** for each additional target symbol that may be required for the same set datum.
- Click **OK** in the **Datum Target Annotation Feature** dialog box.

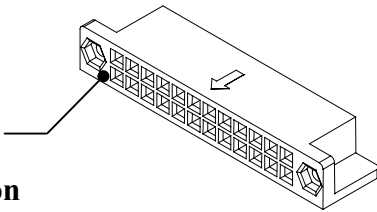
Tutorial – Datum Targets

- **Open** the part called ‘9901-013.prt’
- Click **View, Annotation Orientation**
- Click **Reference Plane** then select this surface 
- Click **Flip** then select **180** for the **Text Rotation**
- Click **OK** in the **Active Annotation Orientation** dialog box
- Orient the part using the saved view called ‘bottom-iso’
- Click **Insert, Annotations, Datum Target Annotation Feature** or click the icon 
- Click **OK** in the **Add Annotation** dialog box
- Select the **BOTTOM** datum plane then enter < B > for the name then click **OK** in the **Set Datum Tag** dialog box
- Click **Add** in the **Datum Target Annotation Feature** dialog box
- Select **On Surface** in the dialog box for the placement type

- Select this surface — then click the middle mouse button here — to place the symbol

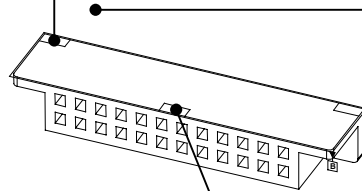

- Click **OK**
- Click **Add** then select this surface — then place the symbol with the MMB
- Click **OK**
- Click **Add** then select this surface — then place the symbol with the MMB

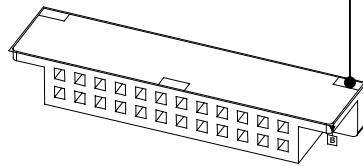

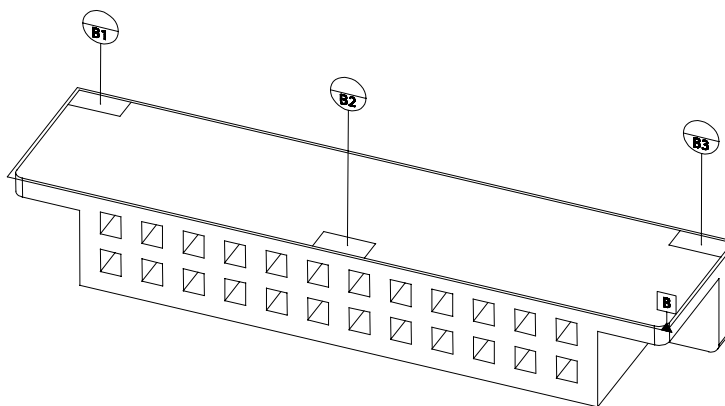

- Click **OK**
- Click **OK** in the **Datum Target Annotation Feature** dialog box
- Set the selection filter to **Annotation**
- Select the set datum symbol then click **Flip** in the RMB popup menu
- The result is shown below
- **Save** the part and **Close** the window



Designated Areas

Annotation elements can be attached to the new **Designated Area** feature. See page 67 for more information about the **Designated Area** feature.

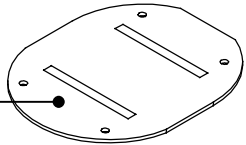
Tutorial – Designated Areas

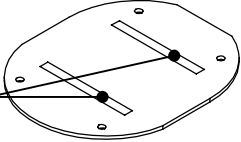
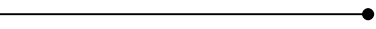
- Be sure that you have completed the **Designated Area** tutorial on page 68
- **Open** the part called ‘4455-009.prt’
- Click **View, Annotation Orientation**
- Click **Reference Plane** in the dialog box then select this surface 
- Click **OK** in the dialog box
- Click **Insert, Annotations, Annotation Feature** or pick the icon 
- Click **Note** and **OK** in the **Add Annotation** dialog box
- Enter < MASK THESE AREAS > for the text in the **Note** dialog box
- Click **Place** in the **Note** dialog box
- Click **With Leader, Standard, Done, On Surface**
- Select the two quilts created by the **Designated Area** feature 
- Click the middle mouse button here to place the note 
- Click **OK** in the **Note** dialog box
- Click **OK** in the **Annotation Feature** dialog box
- **Save** the part and **Close** the window

Move to Plane

There are new options for moving existing annotations to alternate planes.

- For annotation elements, including driven dimensions, use the **Move to Plane** command in the RMB popup menu. The selected entities are moved to the selected plane.
- For driving dimension annotation elements use the **Move Dims to Plane** command in the RMB popup menu. The dimensions are moved to the plane of the first dimension selected.

Select annotation elements then click
Move to Plane in the popup menu

Select multiple driven dimensions
then click **Move Dims to Plane** in
the popup menu

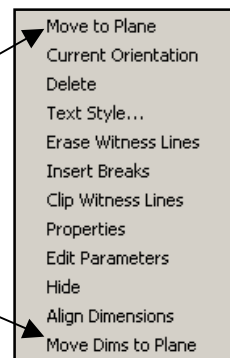

Tutorial – Move to Plane

- **Open** the part called ‘move_annotation.prt’
- Set the selection filter to *Annotation*
- Select the two surface finish symbols and the note then click **Move to Plane** in the RMB popup menu
- Select the FRONT datum plane
- Notice the selected annotation elements are moved to the selected plane
- Select the 1.250 dimension
- Press and hold the Ctrl key and select the other four dimensions
- Click **Move Dims to Plane** in the RMB popup menu
- Notice the dimensions are moved to the plane of the first dimension you selected
- **Save** the part and **Close** the window

Quick Print

The **Quick Print** command now includes an option to print annotation elements that are created using the **Flat to Screen** placement option.

- Click **File, Quick Print**.
- Add the checkmark next to **Print Flat To Screen Annotations** as shown below.
- When this option is checked, only those annotations that were created using the **Flat to Screen** placement option are printed.

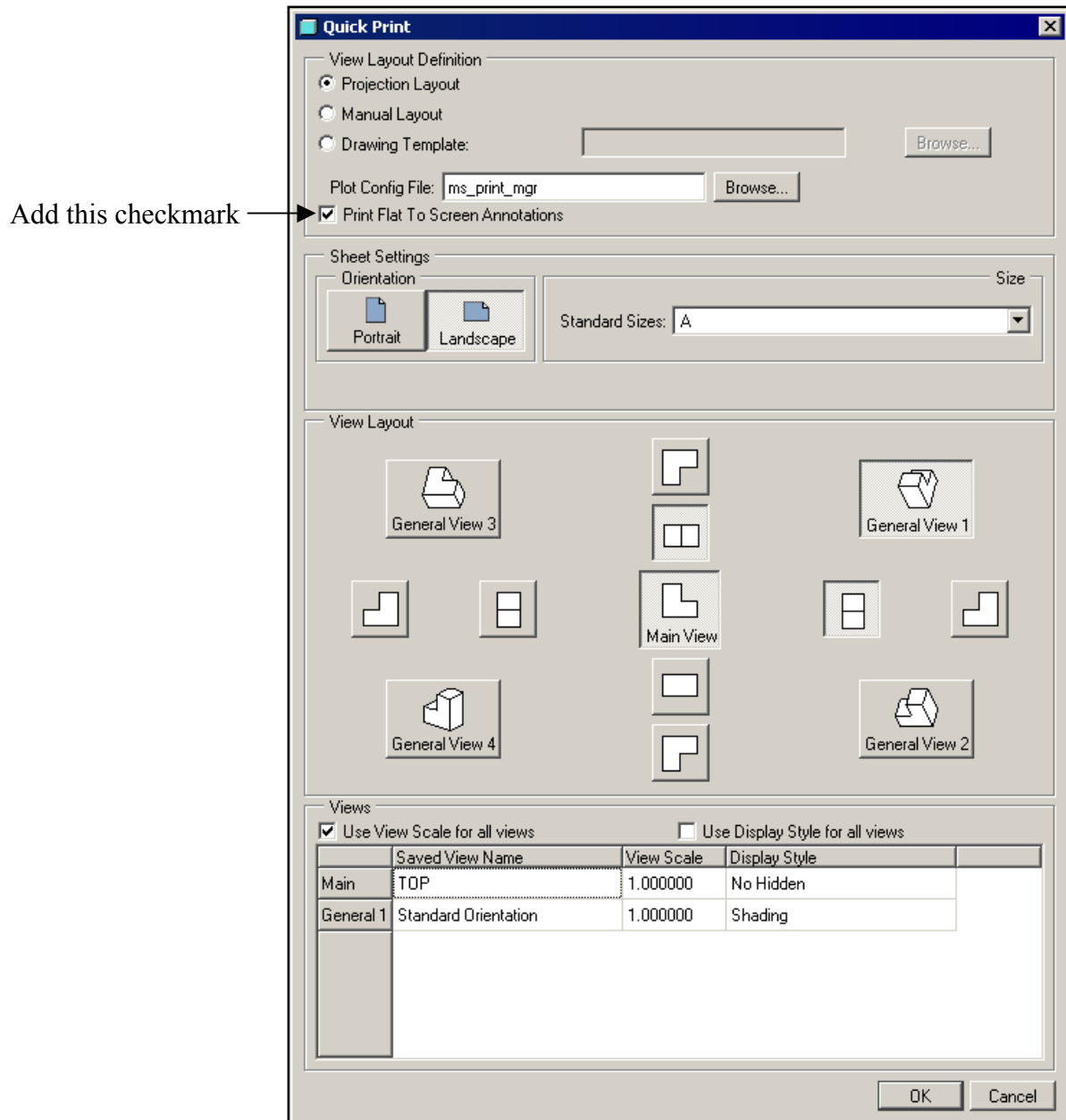





Surface Finish

Enhancements to surface finish annotations are listed below.

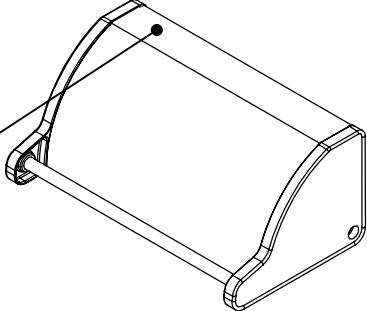
- Surface finish annotations can be dragged off the surface and the system creates a leader line for the symbol.
- Surface finish annotations can now be attached to assembly level quilts.

Tutorial – Surface Finish

- **Open** the part called ‘surface_finish.prt’
- Set the selection filter to **Annotation** then select the surface finish symbol
- Drag the surface finish symbol to the left and off the surface, notice the system creates a leader line for the symbol
- **Save** the part and **Close** the window
- **Open** the assembly called ‘2203-051.asm’
- Set the selection filter to **Geometry** then select this surface 
- Click the **Copy** icon 
- Click the **Paste** icon 
- Click the checkmark in the dashboard tool
- Click **Insert, Annotations, Annotation Feature** or pick the icon 
- Click **Surface Finish** and **OK** in the **Add Annotation** dialog box
- Double click ‘machined’ then double click ‘standard1.sym’
- Select the quilt you just created
- Select **With Leaders** for the placement type in the **Surface Finish** dialog box
- Select the quilt again then click the middle mouse button to place the symbol
- Click **OK** in the **Surface Finish** dialog box
- Click **OK** in the **Annotation Feature** dialog box
- **Save** the assembly and **Close** the window

Text Style

The text style of multiple annotations can now be changed at the same time.

- Set the selection filter to *Annotation*.
- Select multiple annotation elements then click **Text Style** in the RMB popup menu as shown below.

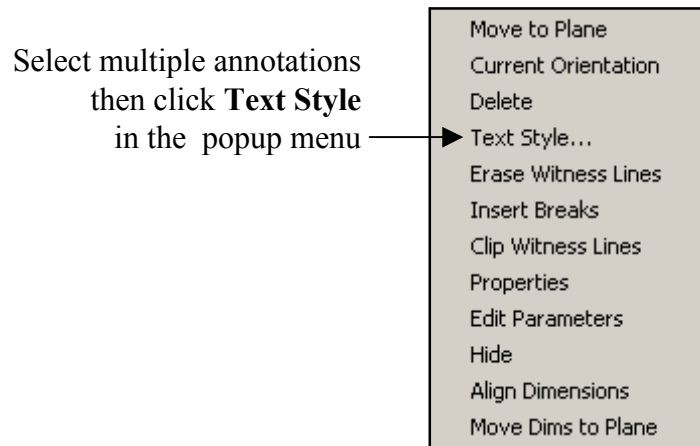

- Change the appropriate settings then click **OK** in the **Text Style** dialog box.

Tutorial – Text Style

- **Open** the part called ‘text_style.prt’
- Set the selection filter to *Annotation*
- Select all the dimensions then click **Text Style** in the RMB popup menu
- Enter < 0.125 > for the text height then click **OK** in the **Text Style** dialog box
- **Save** the part and **Close** the window