

# Datum Features

## Introduction

Datum features are non-solid features used during the construction of other features. The most common datum features include planes, axes, coordinate systems, and curves. Datum features do not add or remove material from the model and therefore do not affect the mass properties of the model. Some datums include 'name tags' as shown below.

Datums are created using the **Insert** menu or the **Datum** toolbar as shown below. Some datum curves such as projected, wrapped, and intersected, are created using the **Edit** menu.

The *display* of datum features can be toggled on/off using the **Datum Display** toolbar, located at the top of the user interface and shown below. The display of datum features can also be toggled on/off using **View, Hide** or by using **Layers**.

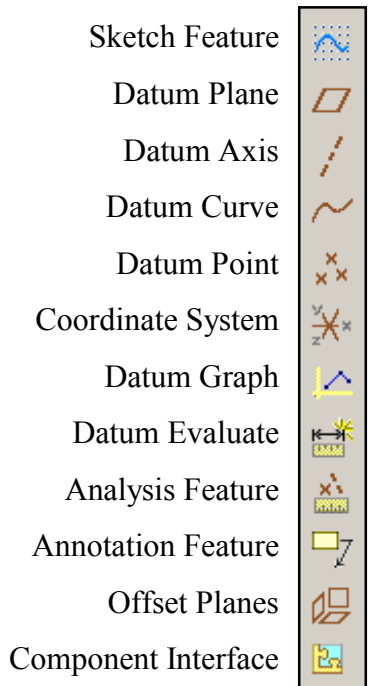

The Datum Toolbar

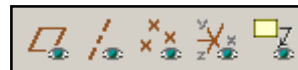
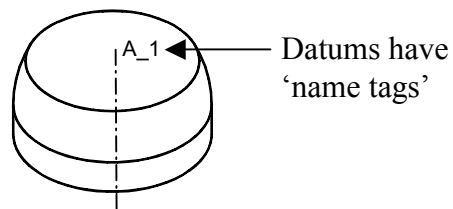

The Datum Display Toolbar



## The Datum Plane Dialog Box

The **Datum Plane** dialog box is used to create datum planes. Select the references for the datum plane *before* selecting the **Datum Plane** icon, shown above. For example, to create an offset datum plane, select the plane to offset from *first*, then pick the icon.

The **Datum Plane** dialog box has three tabs and is shown below.

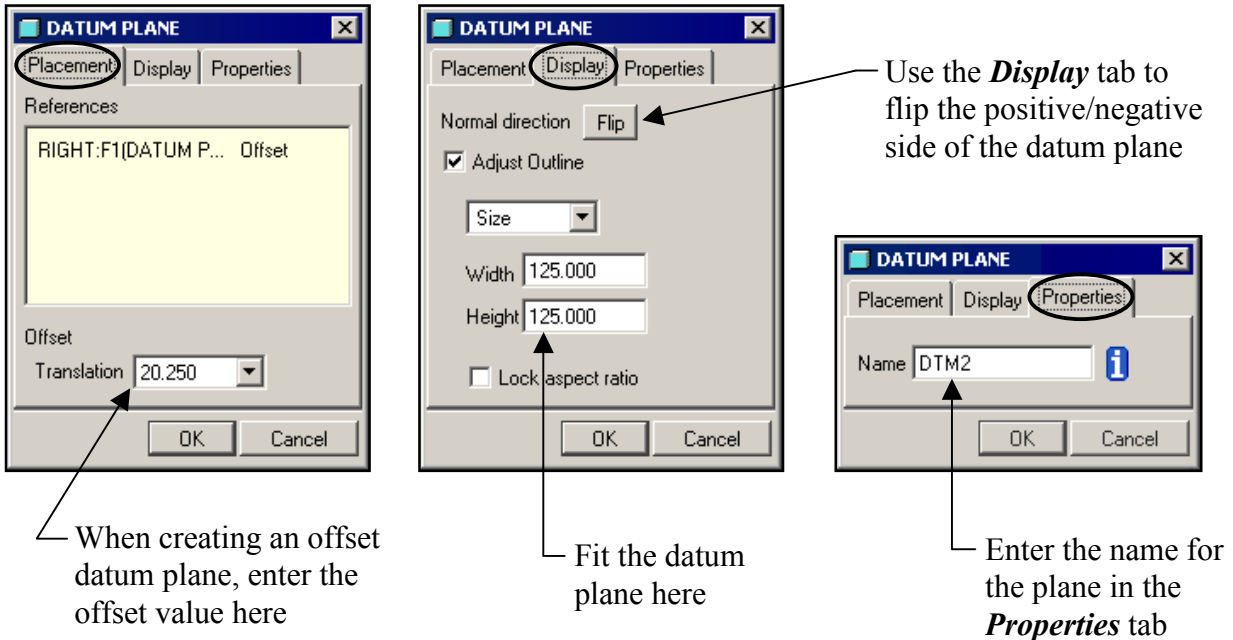

The right mouse button popup menu is shown here

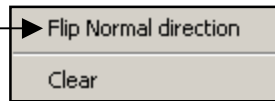

When using an edge and a plane for the references, use this pull down menu to select the type of plane

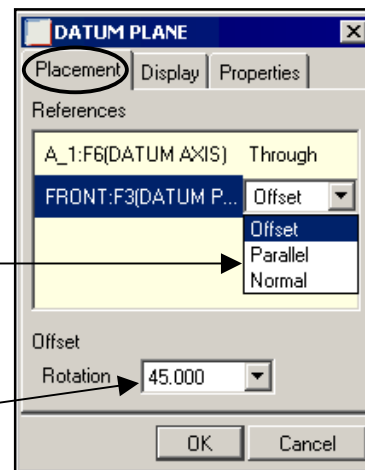

Enter angular rotation here

## Datum Axis

Another common datum feature is the datum axis. Datum axes are created automatically during creation of a hole or revolved feature. Datum axes can be created using the **Datum Toolbar** as shown below. Select the references for the axis *first*, then pick the icon in the toolbar.

Datum axes can be created using combinations of these options:

- Through a linear edge.
- Normal to a datum plane or planar surface.
- Through a datum point.
- Through the center of a cylindrical surface.
- At the intersection of two datum planes or planar surfaces.

Datum axes are used for:

- Creating coaxial holes.
- Centerlines on drawings.
- To indicate symmetry on drawings.
- Geometric tolerances.
- Assembly placement constraints.

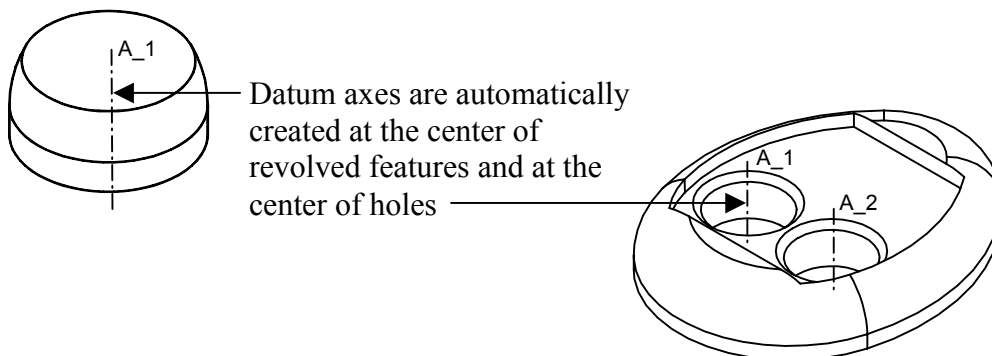

Pick here to create datum axes



## The Datum Axis Dialog Box

The **Datum Axis** dialog box is used to create datum axes. Select the references for the axis *before* selecting the **Datum Axis** icon, shown above. For example, to create an axis at the intersection of two planes, select the two planes *first*, then pick the icon. To create an axis normal to a plane, select the normal plane *first*, then pick the **Datum Axis** icon, then use the right mouse button popup menu to select the offset references.

The **Datum Axis** dialog box has three tabs and is shown below.

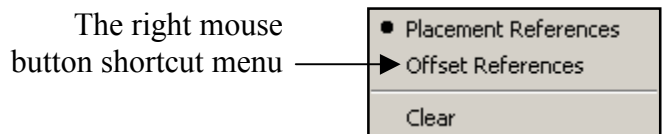
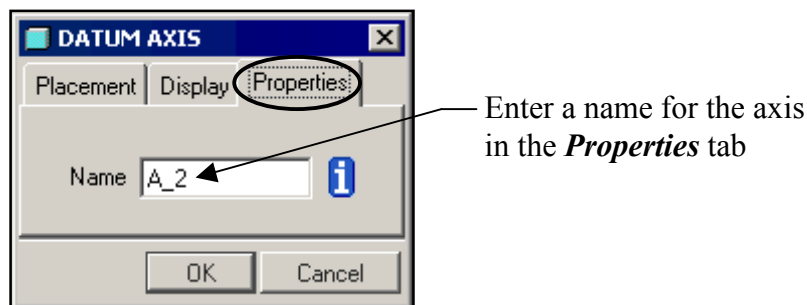
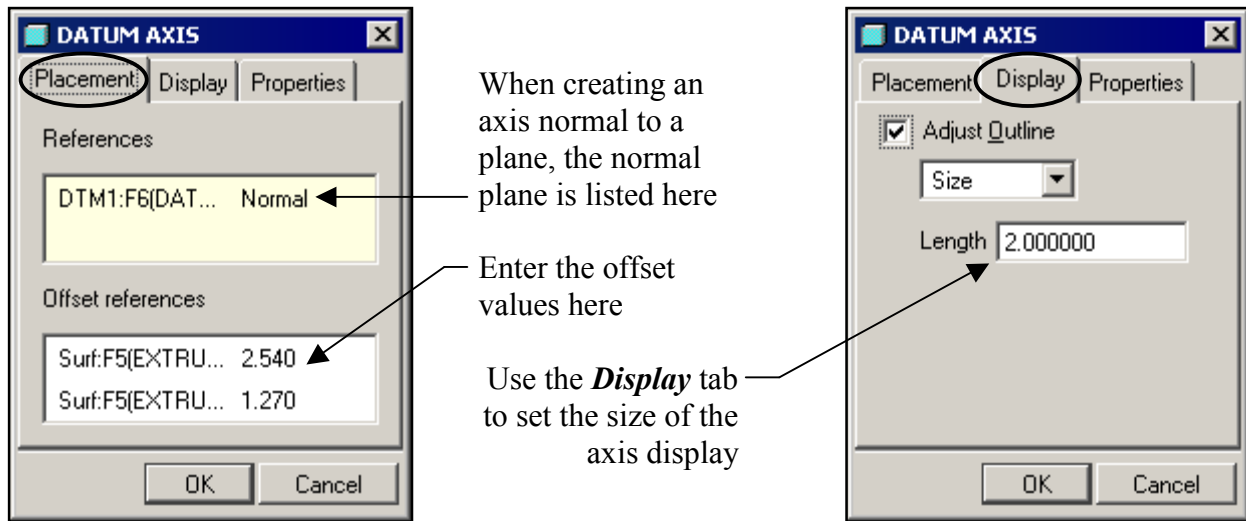

## Datum Coordinate System

Pro/ENGINEER is not an XYZ based CAD system, however, datum coordinate systems can be created using the **Datum** toolbar or the **Insert** menu. The 'default coordinate system' is a special feature located at the intersection of the three default datum planes and can only be created using the **Insert** menu. The template part includes a default coordinate system.

Pro/ENGINEER coordinate systems are 'right-handed': using your right hand, the thumb is the positive X axis, the index finger is the positive Y axis, and the middle finger is the positive Z axis as shown below.

Datum coordinate systems can be created using these options:

- At the intersection of the three default datum planes.
- At the intersection of three datum planes or planar surfaces.
- Offset from another coordinate system by translate and / or rotate.

Datum coordinate systems are used for:

- Measurements.
- Exporting the model to IGES or other file types.
- Assembly constraints.

Pick here to create datum coordinate systems →

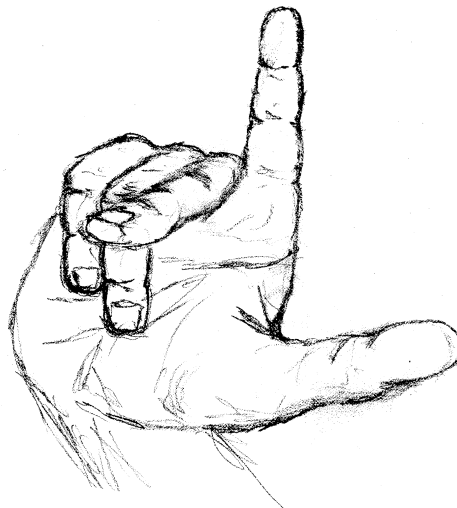
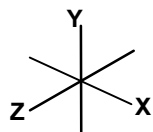

Right Hand Coordinate System

## The Coordinate System Dialog Box

The **Coordinate System** dialog box is used to create all types of datum coordinate systems. Select the references for the coordinate system *before* selecting the icon. For example, select three planes *first* then pick the **Coordinate System** icon.

The **Coordinate System** dialog box has three tabs and is shown below.

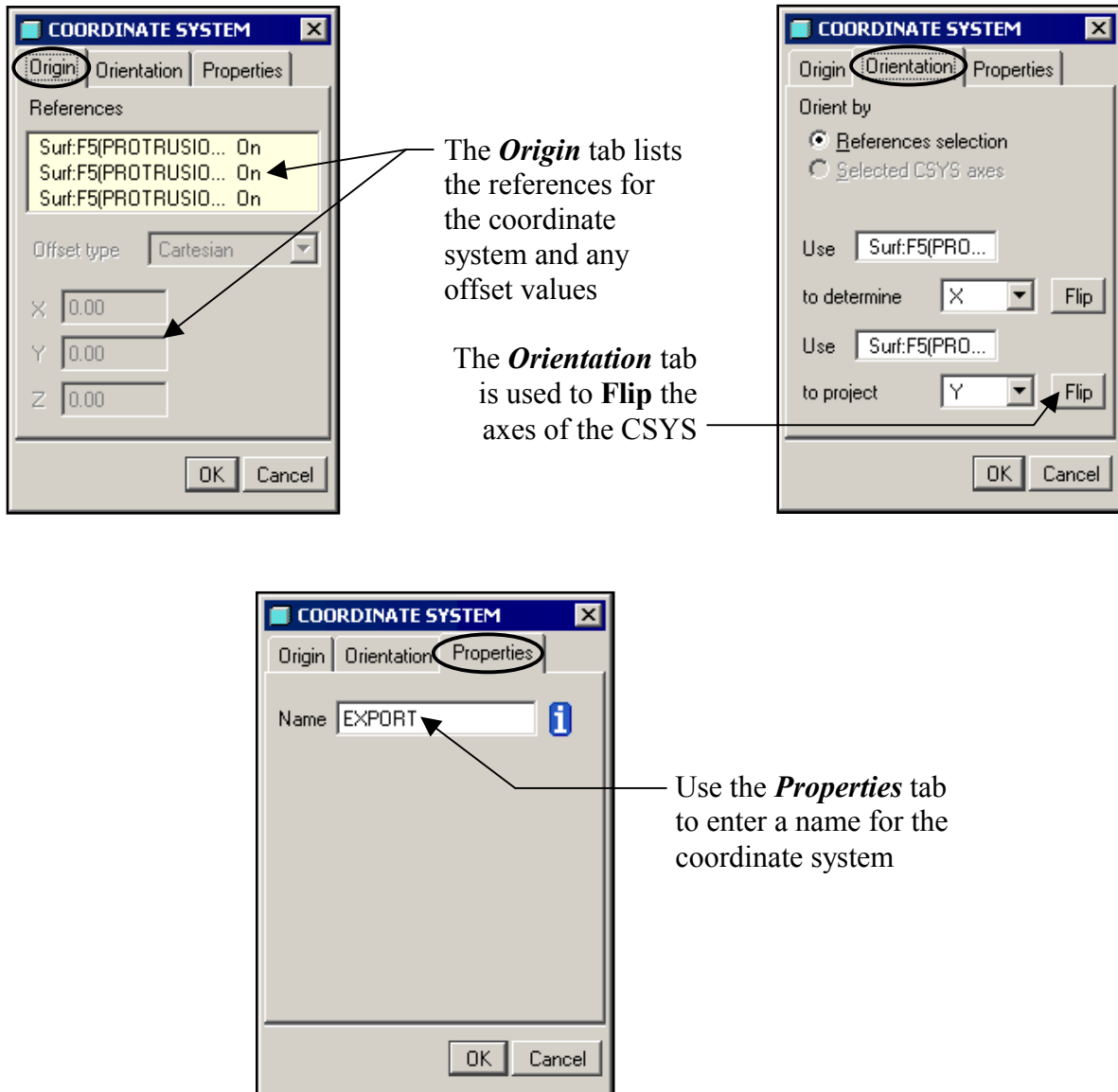

### Sketches and Datum Curves

Datum curves are wireframe geometry with no mass or volume similar to the **Sketch** feature. Sketches and datum curves can be lines, arcs, circles, and splines. Closed loop sketches can be crosshatched. Sketches and datum curves are created using the **Datum Toolbar** as shown below. Some datum curves are also created using the **Edit** menu.

Datum curves can be created using a variety of methods:

- At the intersection of two surfaces
- Projected onto surfaces
- Wrapped onto surfaces
- Through points
- Using the boundary of a surface
- Offset from existing datum curves
- From a file defining points
- From an equation
- Using a cross-section boundary

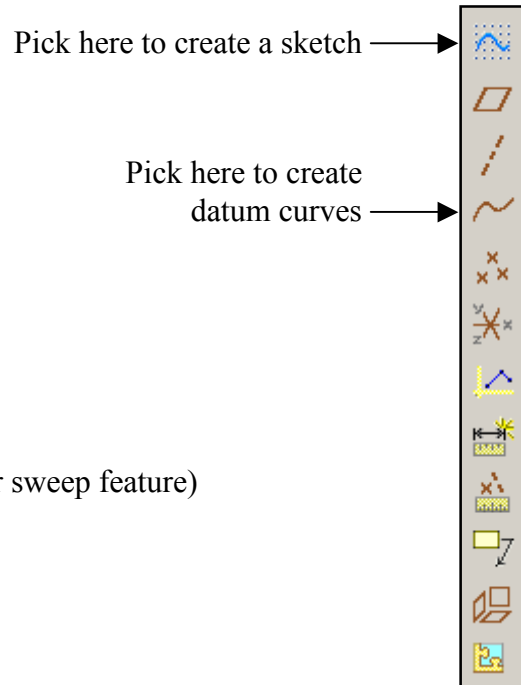

Some uses for datum curves and sketches are:

- References for other features (trajectory for sweep feature)
- Skeleton parts
- Represent other geometry
- To define keep-out areas of a part
- To create labels
- To create a 'filled' area
- Any kind of layout
- To break up complex sketches into several simple sketches

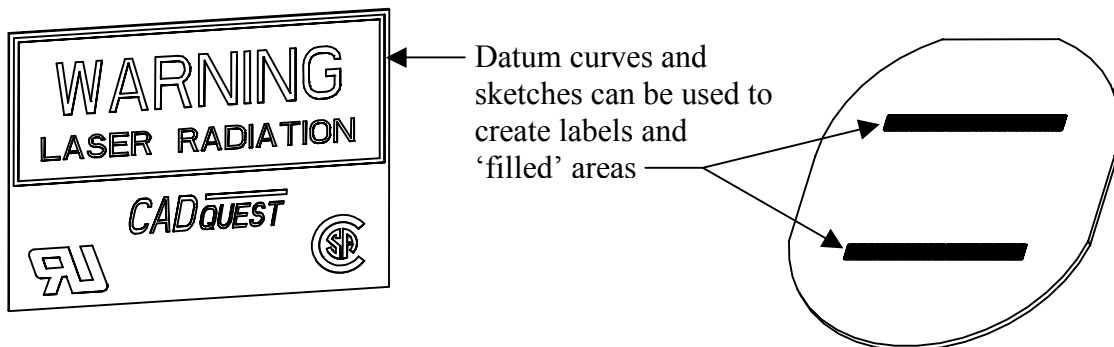

### Line Style of Datum Curves and Sketches

Datum curves and sketches can have alternate line styles and colors applied to affect their display on screen and during printing or plotting. Select the curves then pick **Edit, Properties**. The **Line Style** dialog box is used to select the **Line Font** and **Color** of the datum curve as shown below.

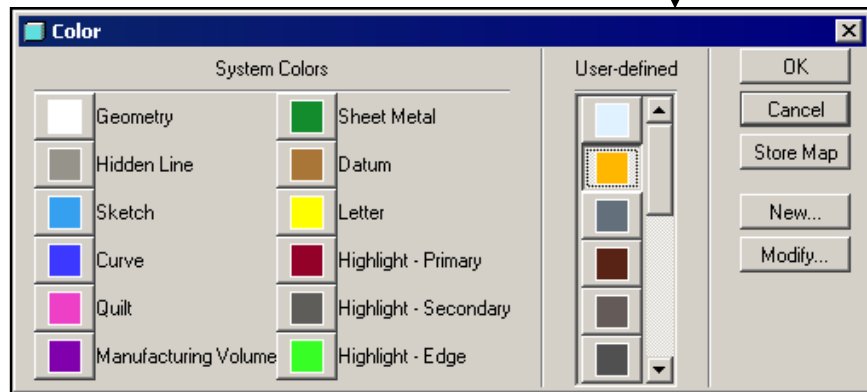
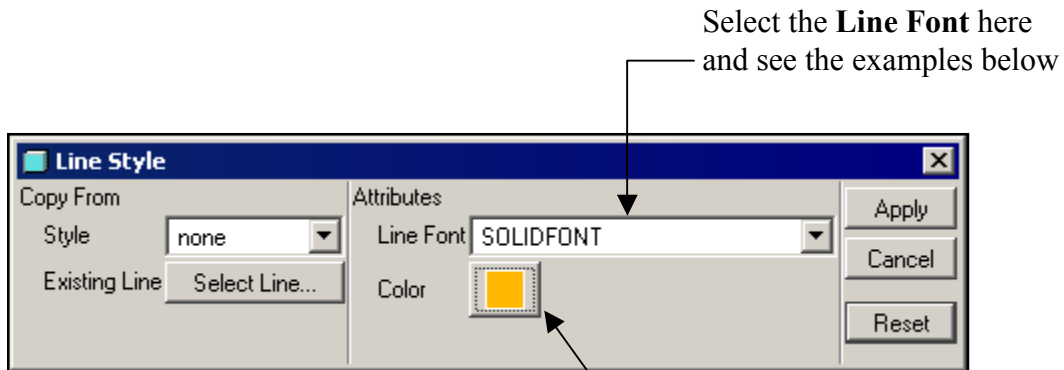

- Solid
- ..... Dotted
- - - - - Centerline
- · — · — Phantom
- — — — Dashed
- ..... Intermittent

**Pro/ENGINEER Line Fonts**

### The Insert Menu

The **Insert** menu can be used to create datum features. For example, pick **Insert, Model Datum, Plane** to create a datum plane. The **Insert** menu is shown below.

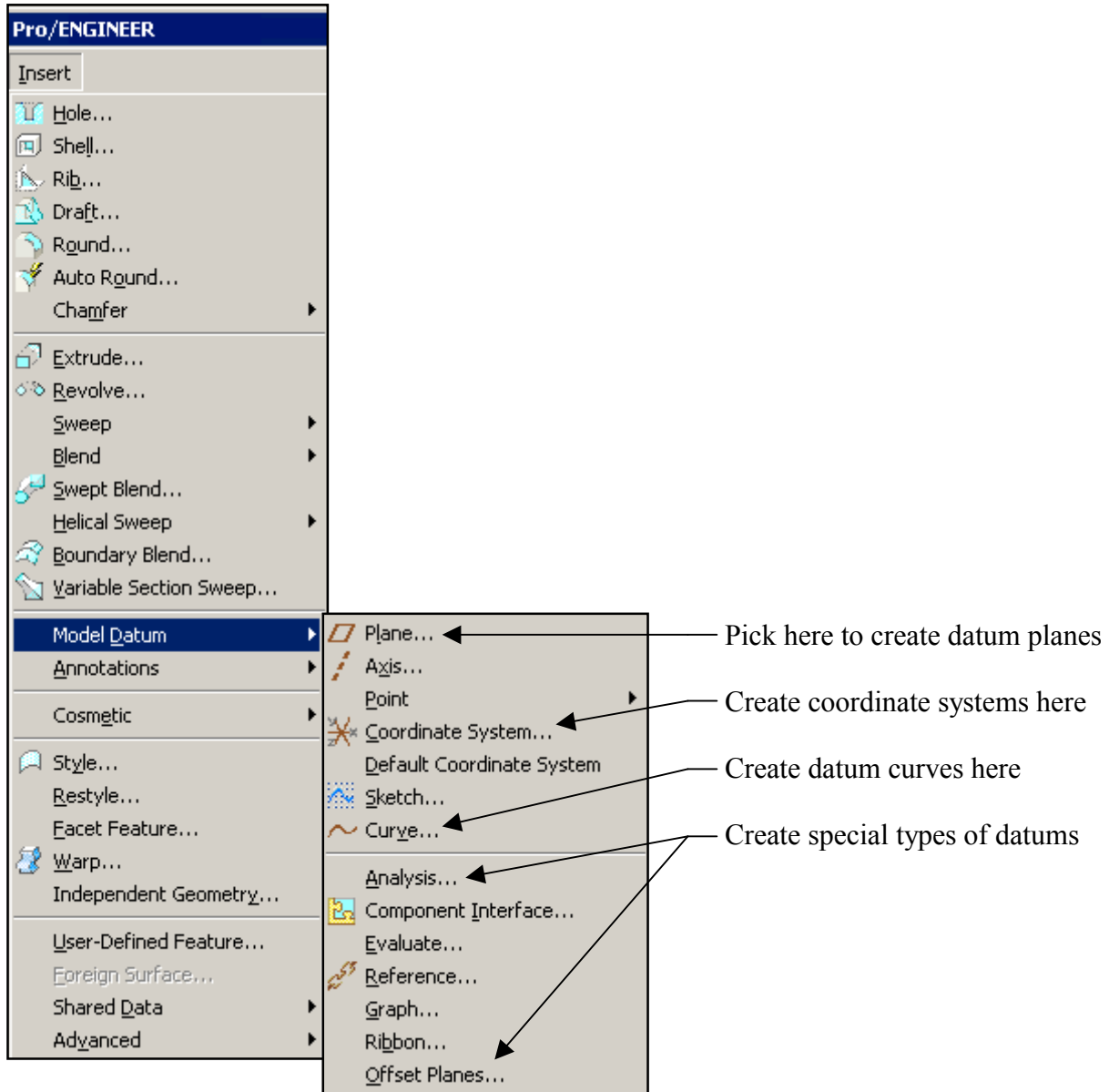

## Using the Hide Command

Individual datum features, such as a single datum plane, can be 'hidden' using the **View, Hide** command. This is similar to using **Layers** to 'hide' the object.

Select the object(s) to be hidden, then pick **View, Visibility, Hide**, or pick the appropriate icon. The **Hide** and **Unhide** icons, shown above, can be added to the interface using the **Tools, Customize Screen** command.

The right mouse button can be used in the model tree to 'hide' datum features. Selected features can be 'unhidden' using the **View, Visibility, Unhide** command. Pick **View, Visibility, Unhide All** to unhide all objects in the current model that are hidden.

Hidden features have a different icon in the model tree as shown below.

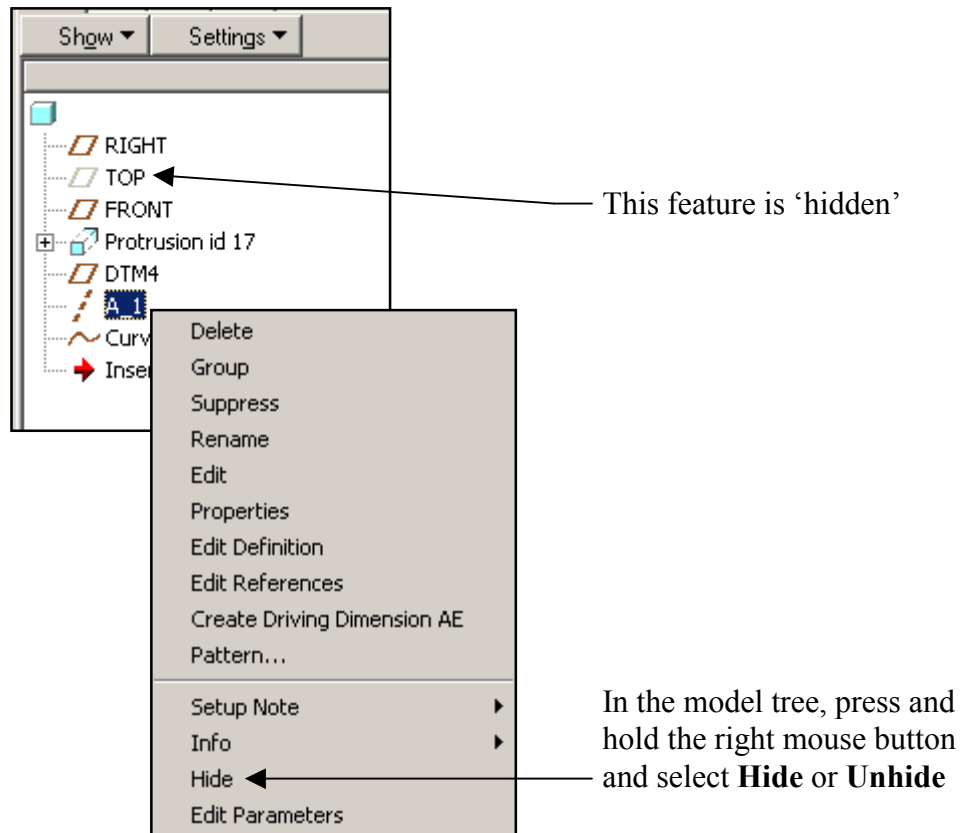

### Datum Name Tags

Datum features have name tags associated with them. The display of these name tags is controlled using the **View, Display Settings, Datum Display** command or the icons shown below. These icons can be added to the user interface using the **Tools, Customize Screen** command.

The **Datum Display** dialog box is shown.

Remove the checkmark to remove the display of the entity



Datum Tag Display Icons

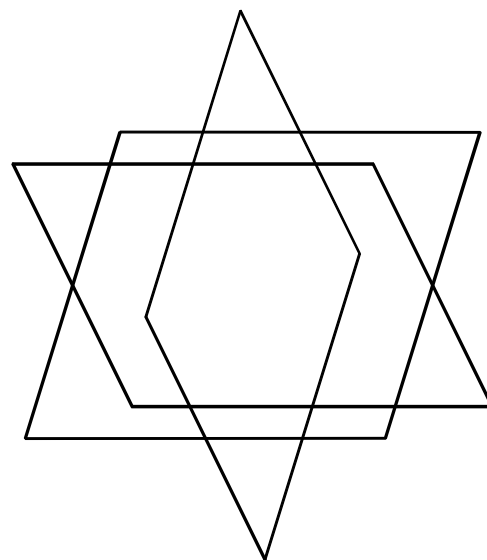
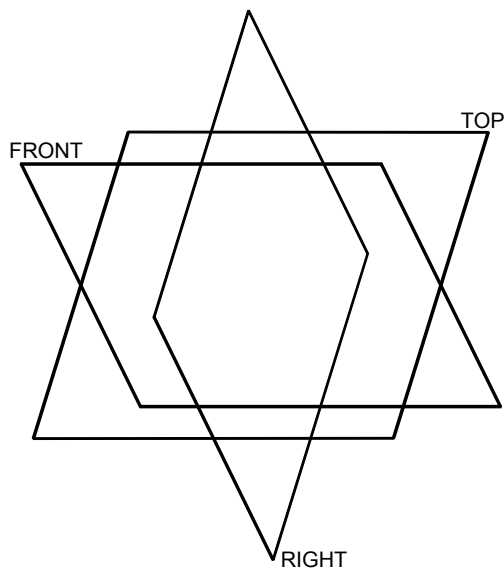
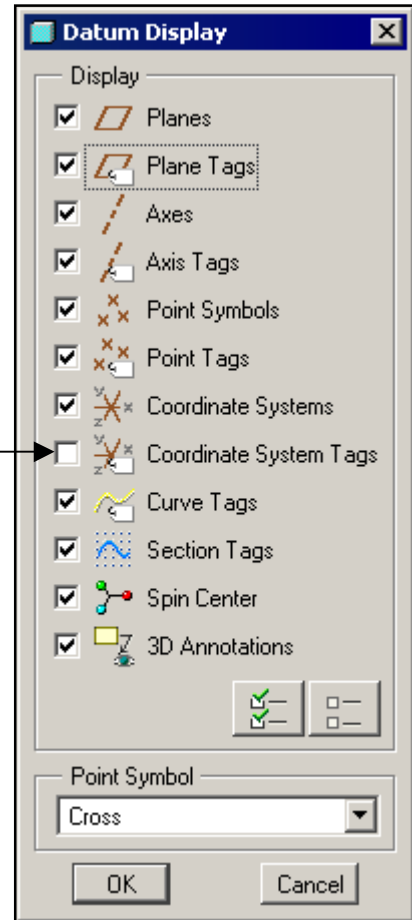

Datum Planes With and Without the Tags Displayed

## EXERCISE 6 - DATUM FEATURES

### *Goal*

The goal of this exercise is to become familiar with creating datum features.

### Task 1: Create a datum plane in 4455-008.

- **Open** the part called '4455-008.prt'
- Pick **View, Orientation, Standard Orientation**
- Set the selection filter to **Datums** (in the lower right corner of the user interface)
- Select the **RIGHT** datum plane
- Pick **Insert, Model Datum, Plane** or pick the icon 
- Enter < 7 > for the offset value in the **Datum Plane** dialog box then pick **OK**
- The result is shown below (DTM1)

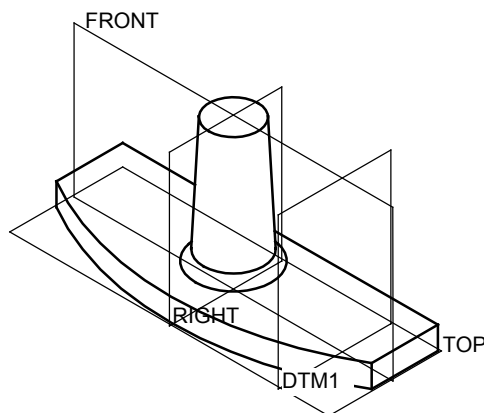



- **Save** the part 
- Pick **File, Close Window**

---

**Task 2: Create datum features in 4455-004.**

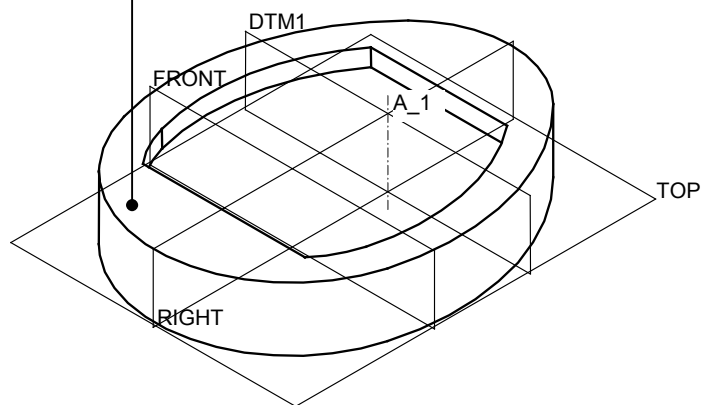

---

- **Open** the part called '4455-004.prt'
- Set the selection filter to **Datums** (in the lower right corner of the user interface)
- Select the FRONT datum plane
- Pick **Insert, Model Datum, Plane** or pick the icon 
- Enter < -14 > for the offset value in the **Datum Plane** dialog box then pick **OK**
- The result is shown below (DTM1)
- Select the RIGHT datum plane
- Press and hold the CTRL key and select the DTM1 datum plane
- Pick **Insert, Model Datum, Axis** or pick the icon 
- The result is shown below (A\_1)
- Set the selection filter to **Geometry**
- Pick this surface in this location

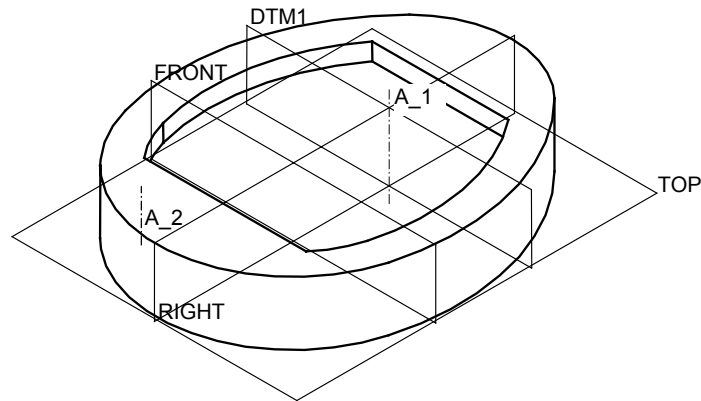

- Pick **Insert, Model Datum, Axis** or pick the icon 
- In the graphics area, drag each of the two 'drag handles' and 'snap' them onto the RIGHT datum plane and the FRONT datum plane
- Double pick the dimension to the RIGHT datum and enter < 10.5 > for the value
- Double pick the dimension to the FRONT datum and enter < 11.5 > for the value
- Pick **OK** in the **Datum Axis** dialog box

- The result is shown below (A\_2)



### Notes

*Where you pick the placement plane determines the positive direction of the locating dimensions.*

*Using a negative value for the locating dimension moves the feature to the opposite side of the reference.*

- Save the part 
- Pick **File, Close Window**

---

### Task 3: Create datum features in 4455-005.

---

- **Open** the part called '4455-005.prt'
- Set the selection filter to **Geometry**
- Pick this surface in this location

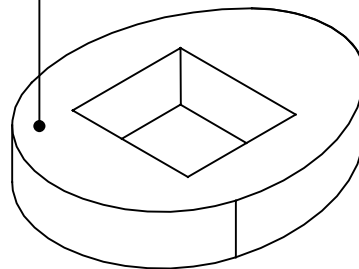

- Pick **Insert, Model Datum, Axis** or pick the icon 
- In the graphics area, drag each of the two 'drag handles' and 'snap' them onto the RIGHT datum plane and the FRONT datum plane
- Double pick the dimension to the RIGHT datum and enter < 10.5 > for the value
- Double pick the dimension to the FRONT datum and enter < 11.5 > for the value
- Pick **OK** in the **Datum Axis** dialog box
- The result is shown below (A\_1)

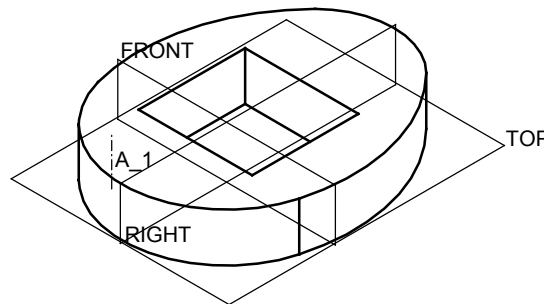

- **Save** the part 
- Pick **File, Close Window**

#### Task 4: Create a datum curve feature in 4455-009.

- **Open** the part '4455-009.prt'
- Pick the **Sketch** icon 
- Pick this surface of the part for the sketch plane

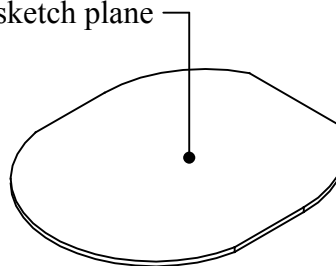

- Pick **Sketch** in the **Sketch** dialog box

- Sketch a vertical centerline aligned with the RIGHT datum plane as shown below
- Sketch and dimension two equal size symmetrical rectangles as shown below

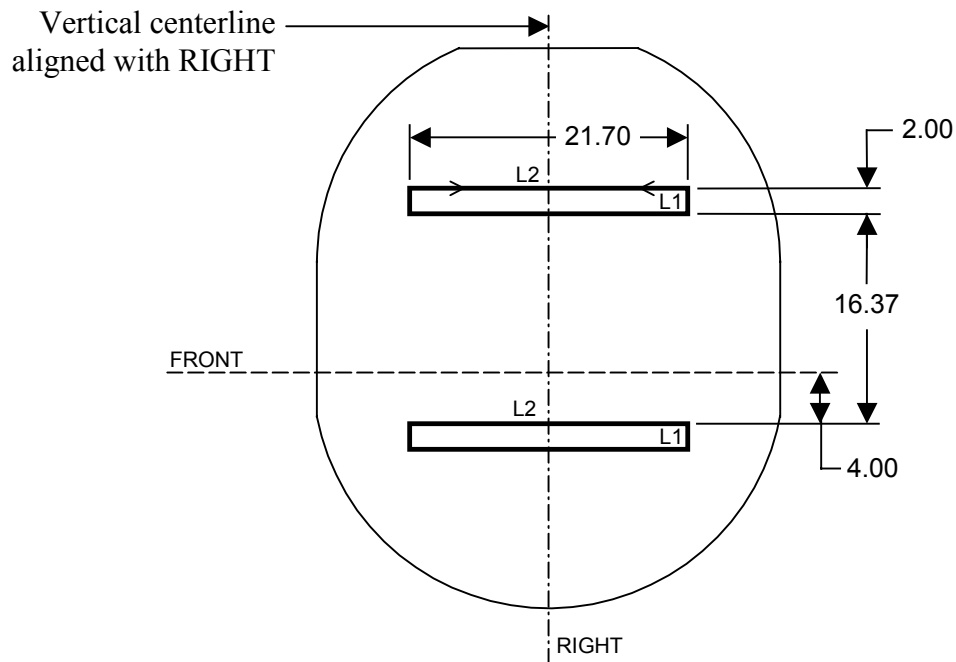

- Modify the dimension values as shown above
- Pick the checkmark to complete the sketch
- Pick **View, Orientation, Standard Orientation**
- The result is shown below

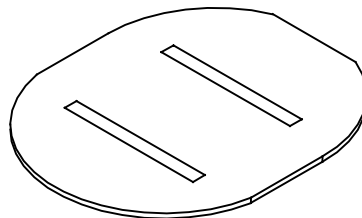



- **Save** the part
- **Close** the window

---

**Task 5: Create datum features in 4455-207.**

---

- **Open** the part called '4455-207.prt'
- Set the selection filter to **Datums**
- Select the TOP datum plane
- Pick **Insert, Model Datum, Axis** or pick the icon 
- Press and hold the right mouse button and select **Offset References** in the popup menu
- Select the RIGHT datum plane and the FRONT datum plane
- Double pick the dimension to the RIGHT datum and enter < -10 > for the value
- Double pick the dimension to the FRONT datum and enter < 22.5 > for the value
- Pick **OK** in the **Datum Axis** dialog box
- In the model tree, pick RIGHT and A\_1
- Pick **Insert, Model Datum, Plane** or pick the icon 
- Enter < -30 > for the angle dimension
- Pick **OK** in the **Datum Plane** dialog box
- The result is shown below

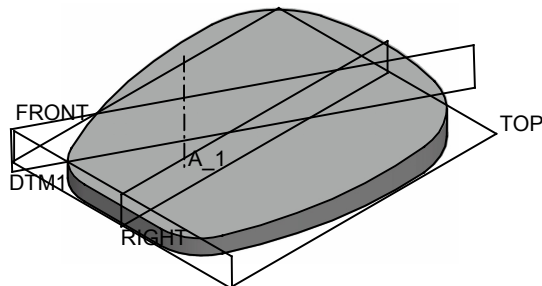



- **Save** the part 
- **Close** the window

---

**Task 6: Create a datum coordinate system.**

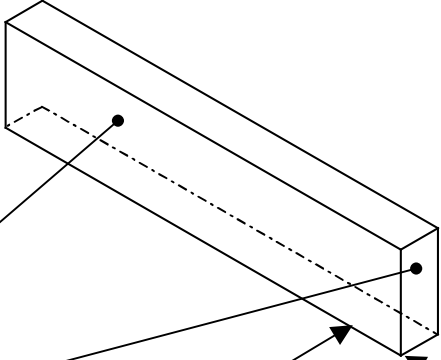
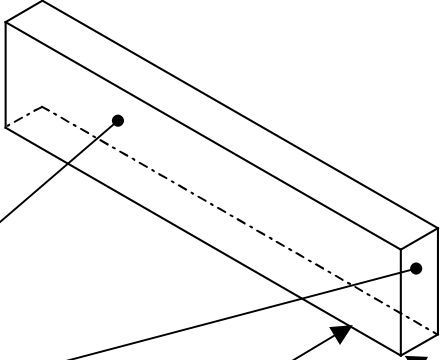
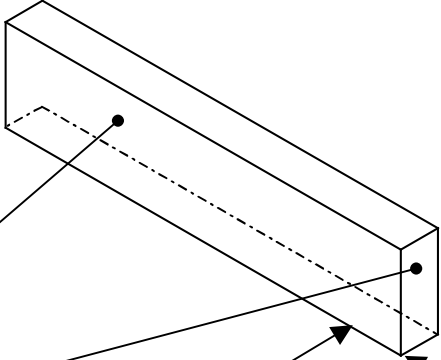
---

- Pick the **Open** icon 
- Double pick the **basic** folder
- Double pick the **labs** folder
- Pick the part 4455-302 then pick **Open**
- Set the selection filter to **Geometry**
- Pick this surface of the part first 
- Press and hold the CTRL key and then pick this surface second 
- Press and hold the CTRL key and then pick the **bottom** surface of the part 
- Pick the **Datum Coordinate System** icon 
- In the **Coordinate System** dialog box, pick the **Orientation** tab and pick **Flip** in the X and Y as shown below

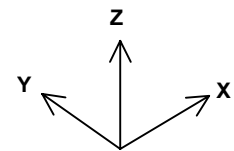

The purpose of this task is to create a datum coordinate system, oriented this direction on this vertex

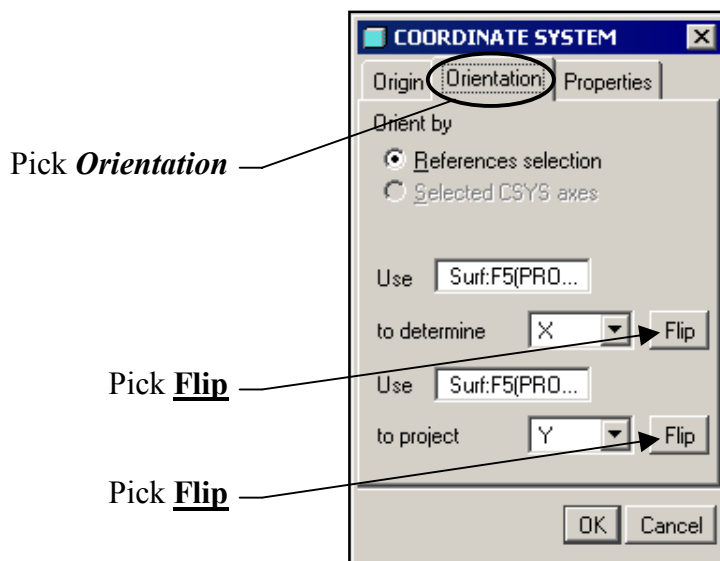

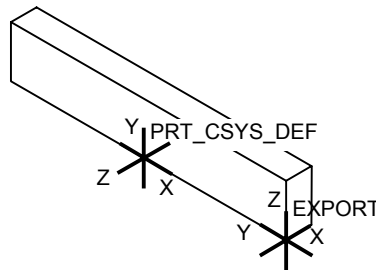

- In the **Coordinate System** dialog box, pick the *Properties* tab
- Enter < export > for the name of the coordinate system
- Pick **OK** in the dialog box
- The result is shown below



- Save the part 
- Pick **File, Close Window**

#### Task 7: Use the hide command.

- Pick the **Open** icon 
- Double pick the **basic** folder, then double pick the **labs** folder
- Pick the part 4455-303 then pick **Open**
- Pick the RIGHT datum plane
- Pick **View, Visibility, Hide**
- Pick the TOP datum plane then press and hold the right mouse button and select **Hide**
- Notice the icon used in the model tree for the hidden features
- Pick **View, Visibility, Save Status**
- Save the part 

#### **Note**

The **Save Status** command forces hidden items to remain hidden after the part is saved and re-opened.

---

**Task 8: Turn off the display of the datum name tags.**

---

- Pick **View, Display Settings, Datum Display**
- Remove the checkmarks next to the name tags as shown below

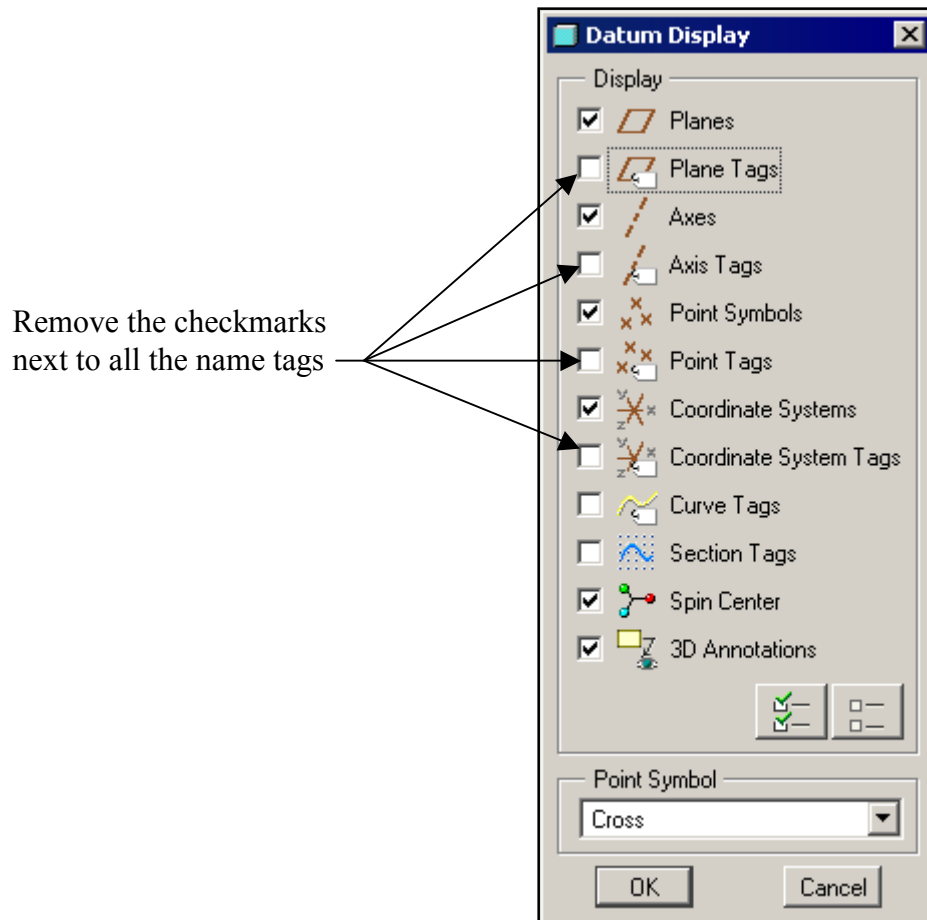

- Pick **OK** in the **Datum Display** dialog box
- Notice the datum name tags are not displayed
- Pick **File, Close Window**
- Pick **File, Exit** then pick **Yes**